

DATA SHEET

SA58780

Sense current amplifier with selectable gain

Product data
Supersedes data of 2002 Dec 10

2003 Nov 10

Sense current amplifier with selectable gain

SA58780

GENERAL DESCRIPTION

The SA58780 is a single amplifier that allows current sensing independent of the supply voltage. The input offset voltage is typically $\pm 500 \mu\text{V}$ with typical offset drift of $\pm 6 \mu\text{V}/^\circ\text{C}$. The SA58780 supply current is typically $150 \mu\text{A}$ and it operates from 3.0 V to 24 V single supply. The input common mode range is selectable for high and low ranges. The amplifier gain is user selected for a "High" of 100 V/V or a "Low" of 50 V/V.

The SA58780 is ideal for battery charger applications in notebook computers and PDAs.

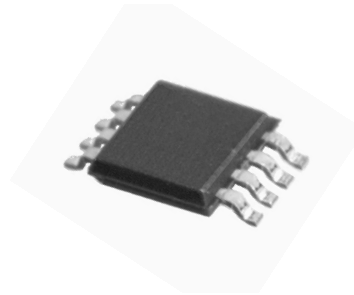

FEATURES

- Supply voltage range: 3 V to 24 V
- Low supply current: $150 \mu\text{A}$ (typical)
- Low input offset voltage: $\pm 500 \mu\text{V}$ (typical)
- Low input offset drift: $\pm 6 \mu\text{V}/^\circ\text{C}$ (typical)
- Power supply rejection ratio (1 kHz): 80 dB (typical)
- Common mode rejection ratio (1 kHz): 100 dB (typical)
- Common mode input range selection:
 - 1.8 V to 24 V ($I_{\text{SEL}} \text{ HIGH}$);
 - -0.3 V to $V_{\text{CC}} - 2.4 \text{ V}$ ($I_{\text{SEL}} \text{ LOW}$)
- Amplifier gain selection:
 - $G_{\text{SEL}} \text{ HIGH}$: $G_V = 100 \text{ V/V}$;
 - $G_{\text{SEL}} \text{ LOW}$: $G_V = 50 \text{ V/V}$

APPLICATIONS

- Notebook computers
- Personal digital assistants (PDA)

SIMPLIFIED DEVICE DIAGRAM

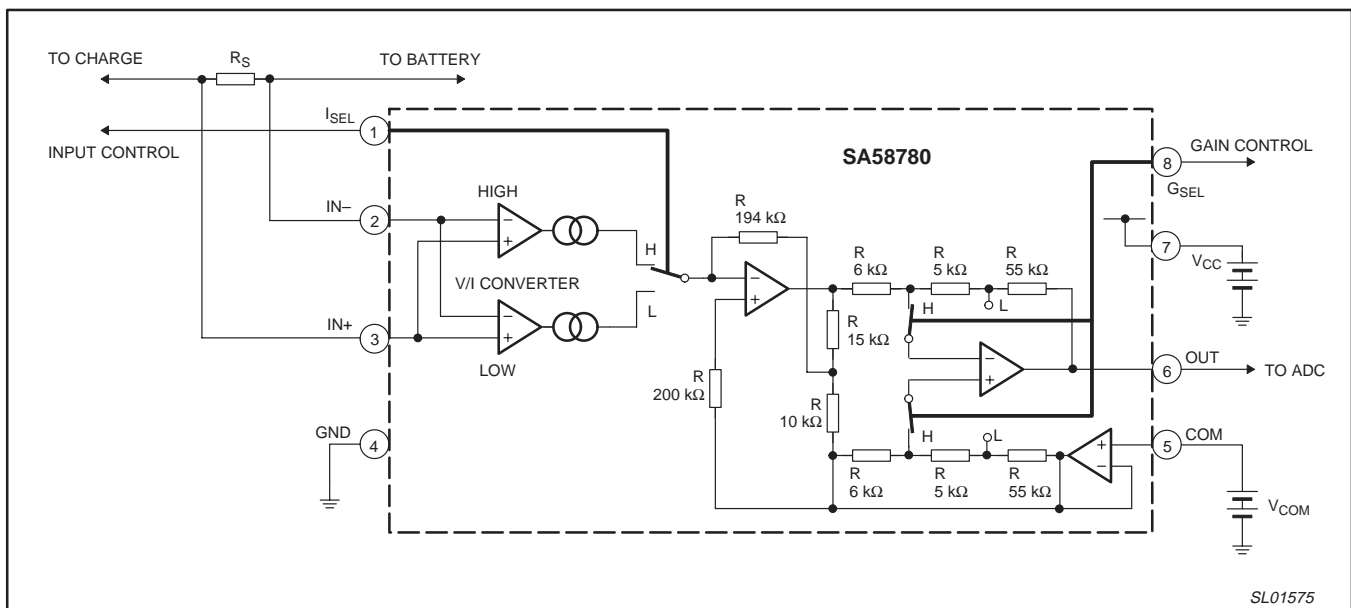

Figure 1. Simplified device diagram.

Sense current amplifier with selectable gain

SA58780

ORDERING INFORMATION

TYPE NUMBER	PACKAGE			TEMPERATURE RANGE
	NAME	DESCRIPTION	VERSION	
SA58780D	SO8	plastic small outline package; 8 leads; body width 3.9 mm	SOP005	-40 °C to +85 °C

PIN CONFIGURATION

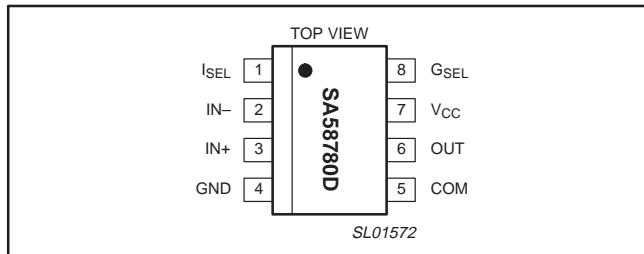

Figure 2. Pin configuration.

PIN DESCRIPTION AND EQUIVALENT CIRCUITS

PIN	SYMBOL	DESCRIPTION	INTERNAL EQUIVALENT CIRCUIT
1	I _{SEL}	Input common mode range selection HIGH: 1.8 V to 24 V LOW: -0.3 V to V _{CC} - 2.4 V	
4	GND	Ground	
2	IN-	Inverting input	
3	IN+	Non-inverting input	
5	COM	Reference voltage input	

Sense current amplifier with selectable gain

SA58780

PIN	SYMBOL	DESCRIPTION	INTERNAL EQUIVALENT CIRCUIT
6	OUT	Output	
7	V _{CC}	Positive supply	
8	G _{SEL}	Gain selection HIGH: 100 V/V LOW: 50 V/V	

MAXIMUM RATINGS

SYMBOL	PARAMETER	MIN.	MAX.	UNIT
V _{CC}	Single supply voltage	-0.3	+25	V
V _{IN}	Input voltage	-0.3	+25	V
T _{stg}	Storage temperature	-40	+125	°C
T _{amb}	Operating ambient temperature	-40	+85	°C
P _D	Power dissipation	-	300	mW

Sense current amplifier with selectable gain

SA58780

ELECTRICAL CHARACTERISTICS $V_{CC} = 5.0\text{ V}$; $V_{ICM} = 15\text{ V}$; $V_{COM} = 25\text{ V}$; $V_{ISEL} = 5\text{ V}$; $V_{GSEL} = 5\text{ V}$; $R_L = 10\text{ k}\Omega$; $T_{amb} = 25\text{ }^\circ\text{C}$, unless otherwise specified.

SYMBOL	PARAMETER	CONDITIONS	MIN.	TYP.	MAX.	UNIT
V_{CC}	Supply voltage operating range		3.0	–	24	V
I_{CC}	Supply current		–	150	200	μA
$G_{V(\text{high})}$	Voltage gain HIGH	$G_{SEL} = 5\text{ V}$	97	100	103	mV/mV
$G_{V(\text{low})}$	Voltage gain LOW	$G_{SEL} = 0\text{ V}$	48.5	50	51.5	mV/mV
V_{IO1}	Input offset voltage 1	$\Delta V_{IN} = 0\text{ V}$; $V_{ISEL} = 5\text{ V (HIGH)}$	–0.5	–	0.5	mV
V_{IO2}	Input offset voltage 2	$\Delta V_{IN} = 0\text{ V}$; $V_{ISEL} = 0\text{ V (LOW)}$	–0.5	–	0.5	mV
ΔV_{IO1}	Input offset voltage 1 temperature coefficient	$V_{ISEL} = 5\text{ V}$	–4	–	4	$\mu\text{V}/^\circ\text{C}$
ΔV_{IO2}	Input offset voltage 2 temperature coefficient	$V_{ISEL} = 0\text{ V}$	–6	–	6	$\mu\text{V}/^\circ\text{C}$
$V_{I(\text{CM})1}$	Common mode input voltage range 1	$V_{ISEL} = 5\text{ V (HIGH)}$	1.8	–	24	V
$V_{I(\text{CM})2}$	Common mode input voltage range 2	$V_{ISEL} = 0\text{ V (LOW)}$	–0.3	–	$V_{CC} - 2.4$	V
$V_{I(\text{dif})}$	Differential input voltage		–200	–	200	mV
$I_{i(\text{bias})1}$	Input bias current 1	$\Delta V_{IN} = 0\text{ V}$; $V_{ISEL} = 5\text{ V (HIGH)}$	0.8	1.2	1.6	μA
$I_{i(\text{bias})2}$	Input bias current 2	$\Delta V_{IN} = 0\text{ V}$; $V_{ISEL} = 0\text{ V (LOW)}$	–0.8	–1.2	–1.6	μA
$\Delta V_{IO}/\Delta T$	Input offset voltage temperature drift	$T_{amb} = -40\text{ to }+85\text{ }^\circ\text{C}$	–	± 1	± 3	$\mu\text{V}/^\circ\text{C}$
Z_i	Input impedance		100	–	–	k Ω
V_{COM}	COM voltage range	$R_L = \text{open}$	1.2	–	$V_{CC} - 1.2$	V
I_{SEL}	I_{SEL} current	$V_{ISEL} = 5\text{ V}$	–	1.0	–	μA
V_{ISEL1}	I_{SEL} voltage range 1 (HIGH)		1.7	–	24	V
V_{ISEL2}	I_{SEL} voltage range 2 (LOW)		0	–	0.5	V
I_{GSEL}	G_{SEL} sink current	$V_{GSEL} = 5\text{ V}$	–	1.0	–	μA
V_{GSEL1}	G_{SEL} voltage range 1	(100 V/V)	1.7	–	24	V
V_{GSEL2}	G_{SEL} voltage range 2	(50 V/V)	0	–	0.5	V
V_{OUT}	Output voltage range	$R_L = \text{open}$	0.3	–	$V_{CC} - 0.3$	V
$I_{O(\text{source})}$	Output source current	$V_{OUT} = V_{CC} - 0.3\text{ V}$	0.5	1.0	–	mA
$I_{O(\text{sink})}$	Output sink current	$V_{OUT} = 0.3\text{ V}$	–0.5	–1.0	–	mA
f_{C1}	Cutoff frequency 1	$V_{GSEL} = 5\text{ V}$ ($G_{V(\text{high})} = 100\text{ V/V}$); $V_{OUT} = -3\text{ dB}$	–	100	–	kHz
f_{C2}	Cutoff frequency 2	$V_{GSEL} = 0\text{ V}$ ($G_{V(\text{low})} = 50\text{ V/V}$); $V_{OUT} = -3\text{ dB}$	–	140	–	kHz
PSRR1	Power supply rejection ratio 1	$f = 1\text{ kHz}$; $V_{ISEL} = 5\text{ V}$	70	80	–	dB
PSRR2	Power supply rejection ratio 2	$f = 1\text{ kHz}$; $V_{ISEL} = 0\text{ V}$	70	80	–	dB
CMRR1	Common mode rejection ratio 1	$f = 1\text{ kHz}$; $V_{ISEL} = 5\text{ V}$	70	80	–	dB
CMRR2	Common mode rejection ratio 2	$f = 1\text{ kHz}$; $V_{ISEL} = 0\text{ V}$	70	80	–	dB

Sense current amplifier with selectable gain

SA58780

TYPICAL CHARACTERIZATION CURVES

$V_{CC} = 5.0\text{ V}$; $V_{GSEL} = V_{ISEL} = 5\text{ V}$; $R_L = 10\text{ k}\Omega$; $T_{amb} = 25\text{ }^\circ\text{C}$; unless otherwise specified.

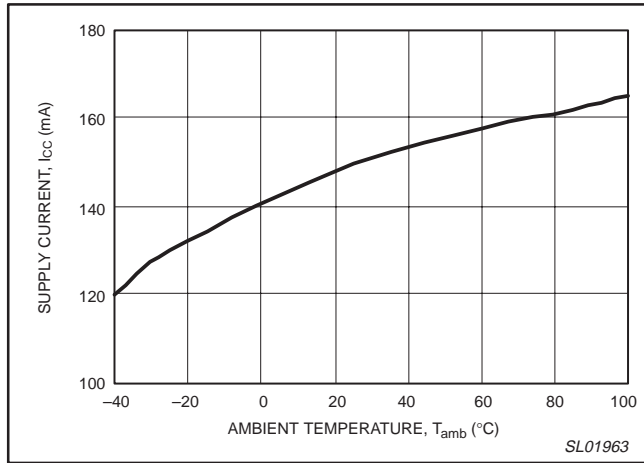

Figure 3. Supply current versus ambient temperature.

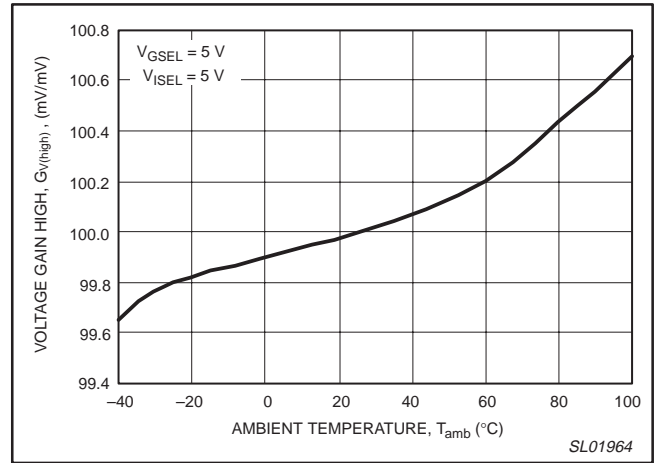

Figure 4. Voltage Gain 1 (HIGH) versus ambient temperature.

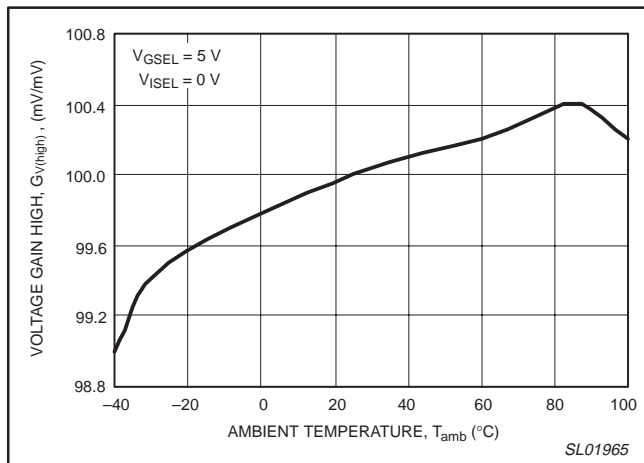

Figure 5. Voltage Gain 1 (HIGH) versus ambient temperature.

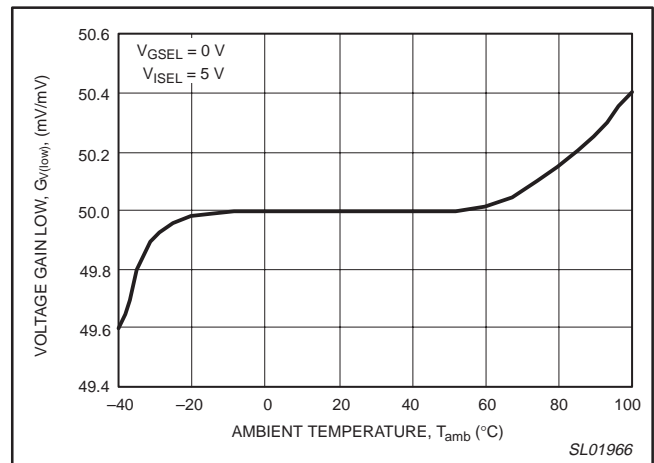

Figure 6. Voltage Gain 2 (LOW) versus ambient temperature.

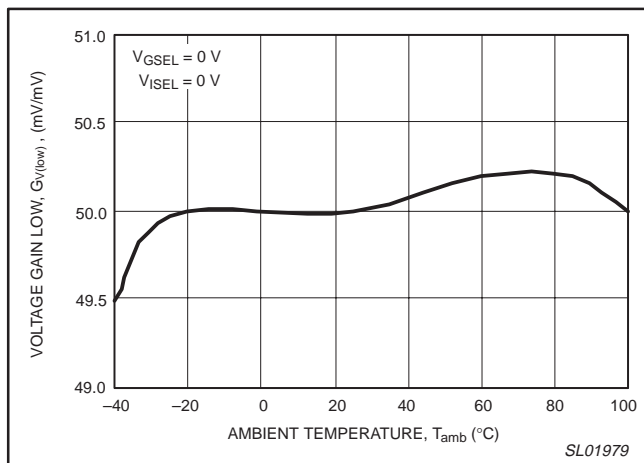

Figure 7. Voltage Gain 2 (LOW) versus ambient temperature.

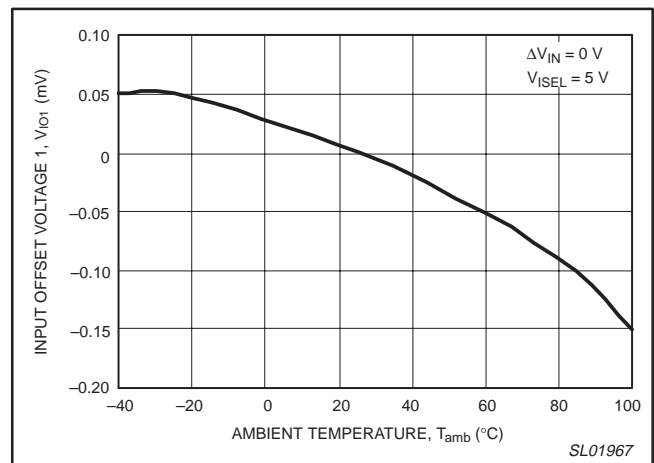

Figure 8. Input offset voltage 1 versus ambient temperature.

Sense current amplifier with selectable gain

SA58780

TYPICAL CHARACTERIZATION CURVES (continued)

$V_{CC} = 5.0\text{ V}$; $V_{GSEL} = V_{ISEL} = 5\text{ V}$; $R_L = 10\text{ k}\Omega$; $T_{amb} = 25\text{ }^\circ\text{C}$; unless otherwise specified.

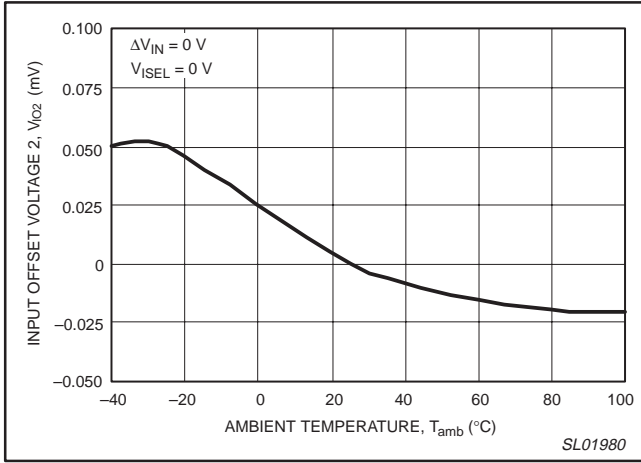

Figure 9. Input offset voltage 1 versus ambient temperature.

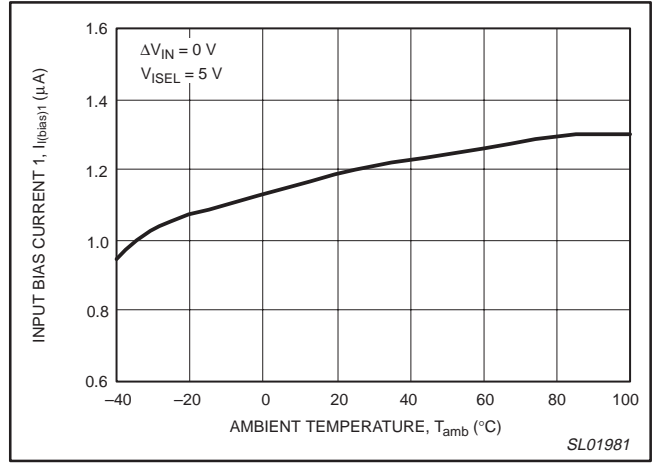

Figure 10. Input bias current versus ambient temperature.

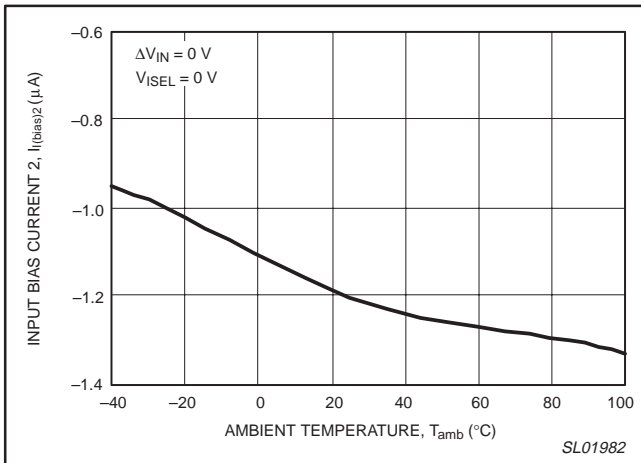

Figure 11. Input bias current versus ambient temperature.

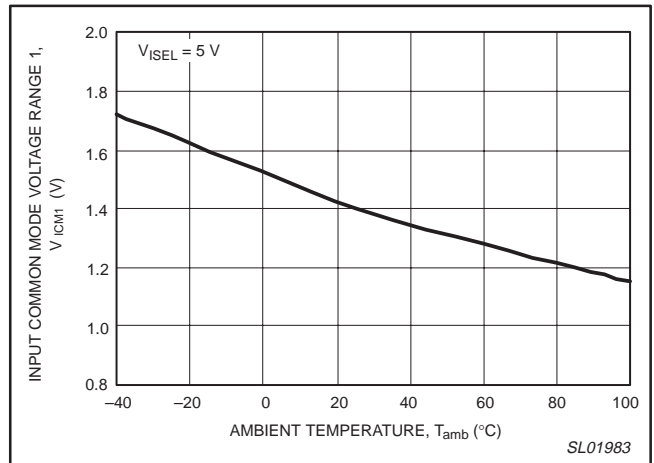

Figure 12. Input common mode voltage (minimum) versus ambient temperature.

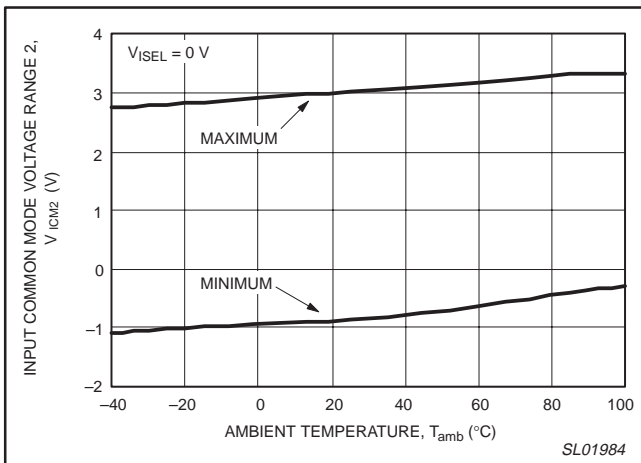

Figure 13. Input common mode voltage range 2 versus ambient temperature.

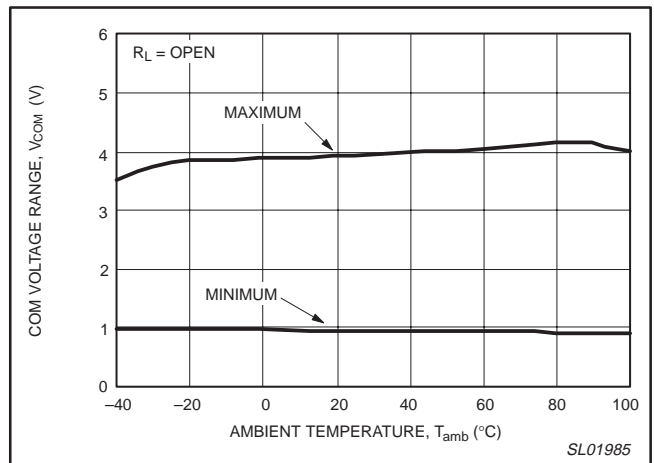

Figure 14. COM voltage range versus ambient temperature.

Sense current amplifier with selectable gain

SA58780

TYPICAL CHARACTERIZATION CURVES (continued)

$V_{CC} = 5.0\text{ V}$; $V_{GSEL} = V_{ISEL} = 5\text{ V}$; $R_L = 10\text{ k}\Omega$; $T_{amb} = 25\text{ }^\circ\text{C}$; unless otherwise specified.

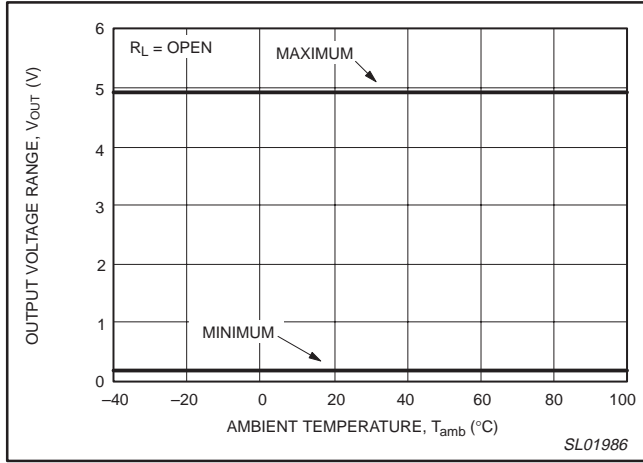

Figure 15. Output voltage range versus ambient temperature.

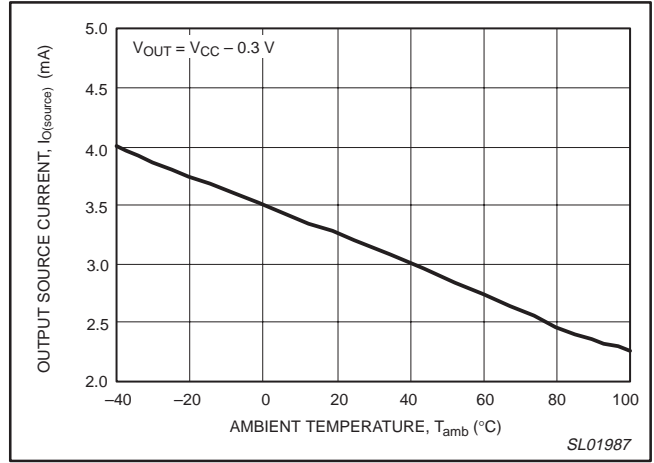

Figure 16. Output source current versus ambient temperature.

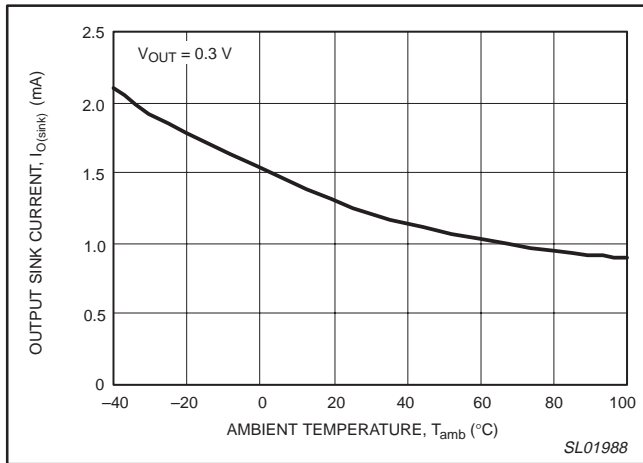

Figure 17. Output sink current versus ambient temperature.

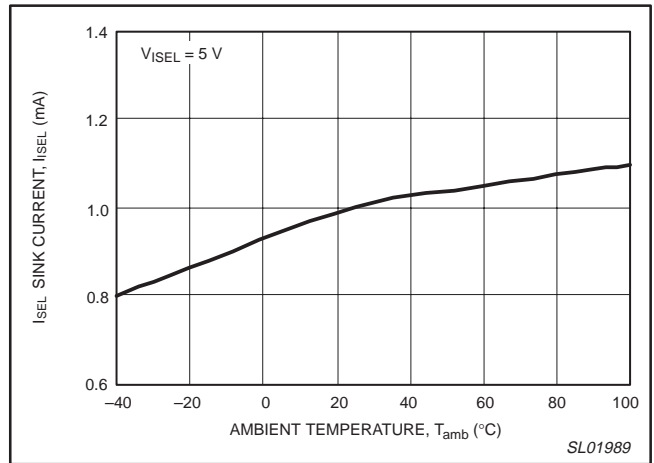

Figure 18. I_{SEL} sink current versus ambient temperature.

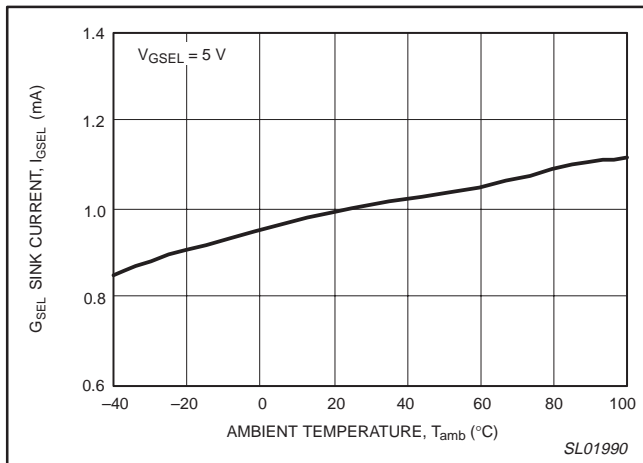

Figure 19. G_{SEL} sink current versus ambient temperature.

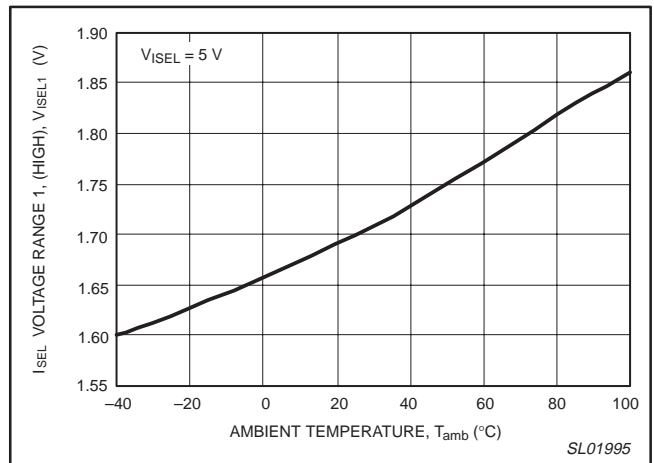

Figure 20. I_{SEL} voltage range 1 versus ambient temperature.

Sense current amplifier with selectable gain

SA58780

TYPICAL CHARACTERIZATION CURVES (continued)

$V_{CC} = 5.0\text{ V}$; $V_{GSEL} = V_{ISEL} = 5\text{ V}$; $R_L = 10\text{ k}\Omega$; $T_{amb} = 25\text{ }^\circ\text{C}$; unless otherwise specified.

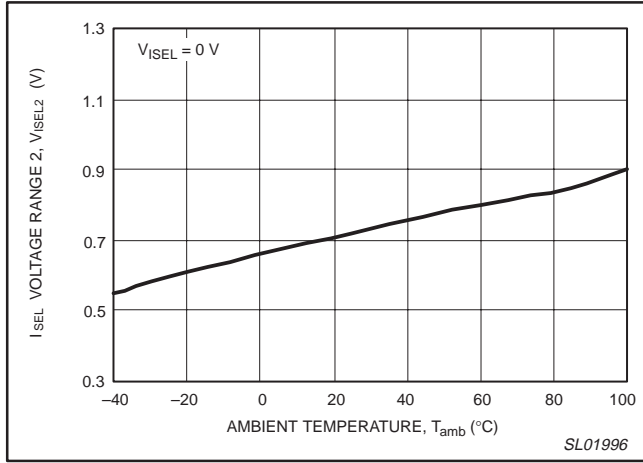

Figure 21. I_{SEL} voltage range 2 versus ambient temperature.

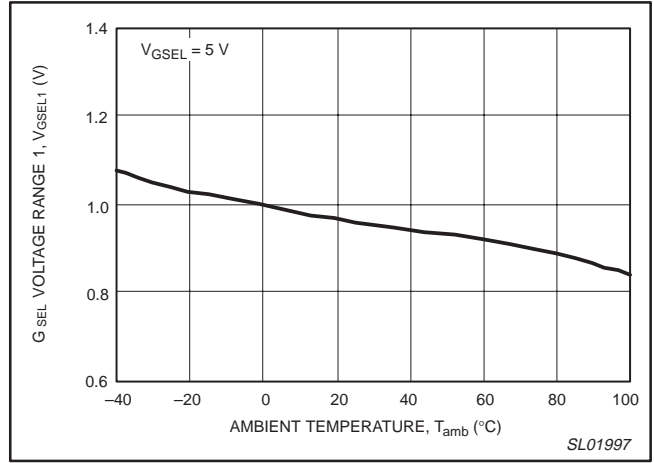

Figure 22. G_{SEL} voltage range 1 versus ambient temperature.

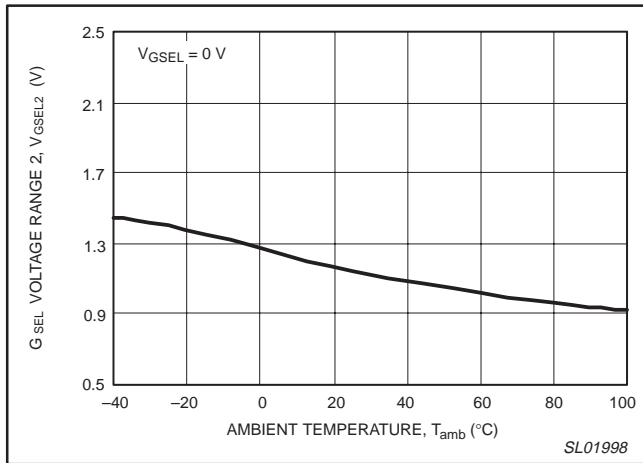

Figure 23. G_{SEL} voltage range 2 versus ambient temperature.

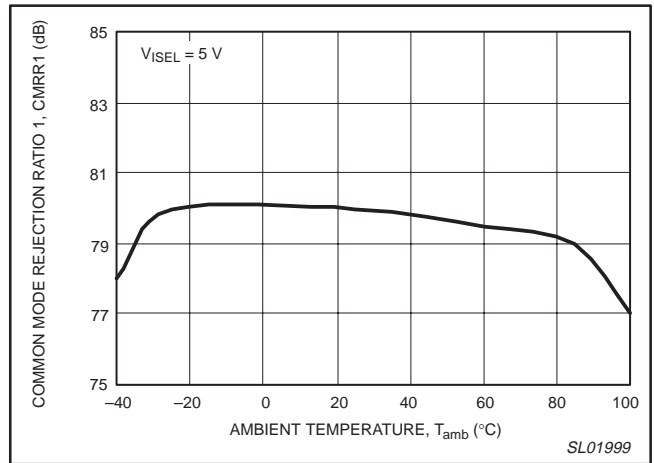

Figure 24. Common mode rejection ratio 1 versus ambient temperature.

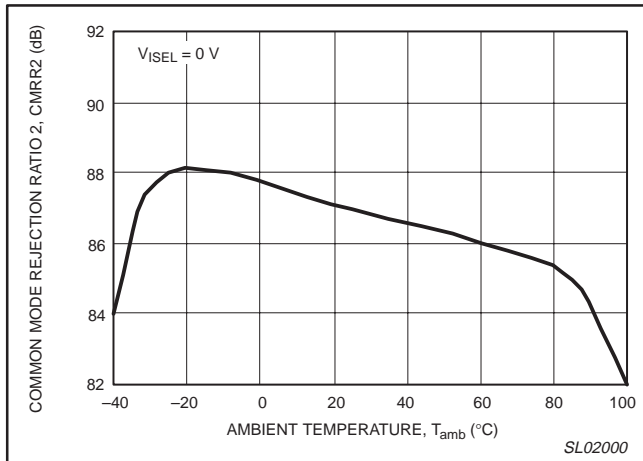

Figure 25. Common mode rejection ratio 2 versus ambient temperature.

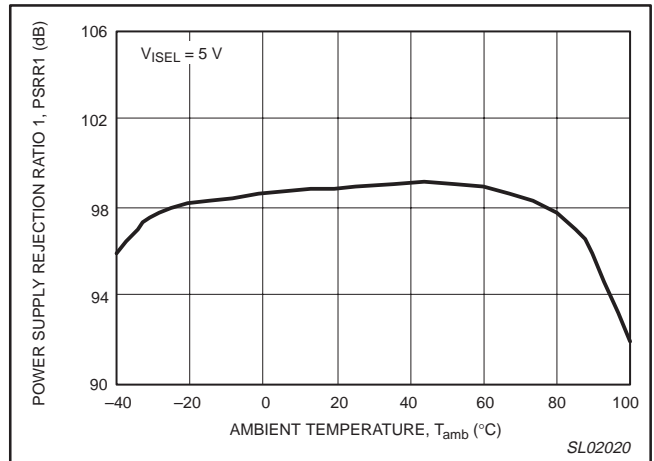

Figure 26. Power supply rejection ratio 1 versus ambient temperature.

Sense current amplifier with selectable gain

SA58780

TYPICAL CHARACTERIZATION CURVES (continued)

$V_{CC} = 5.0\text{ V}$; $V_{GSEL} = V_{ISEL} = 5\text{ V}$; $R_L = 10\text{ k}\Omega$; $T_{amb} = 25\text{ }^\circ\text{C}$; unless otherwise specified.

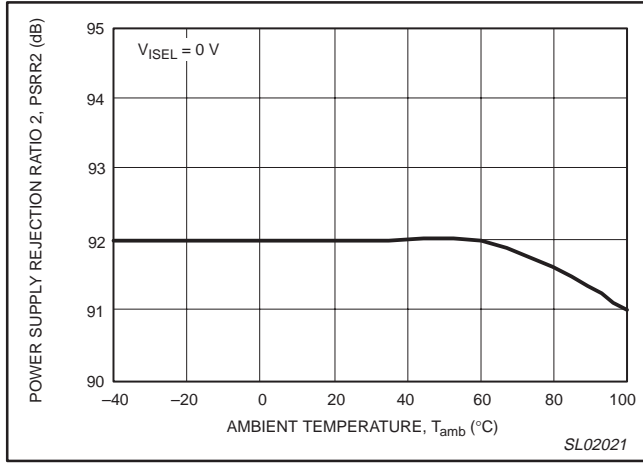

Figure 27. Power supply rejection ratio 2 versus ambient temperature.

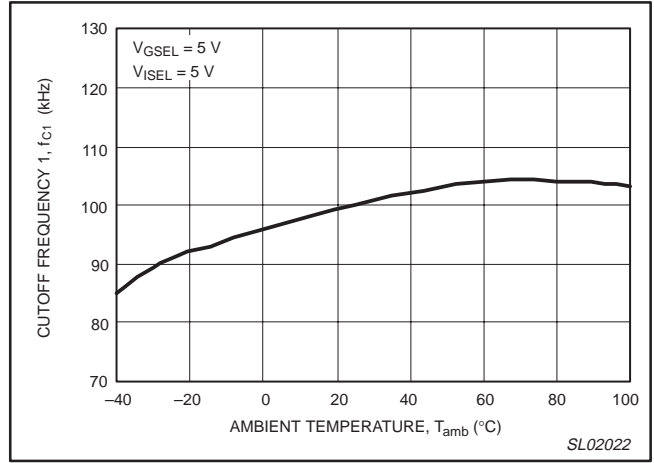

Figure 28. Cutoff frequency 1 versus ambient temperature.

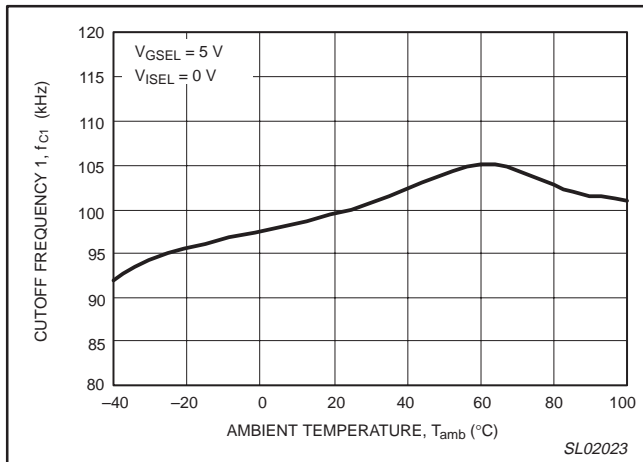

Figure 29. Cutoff frequency 1 versus ambient temperature.

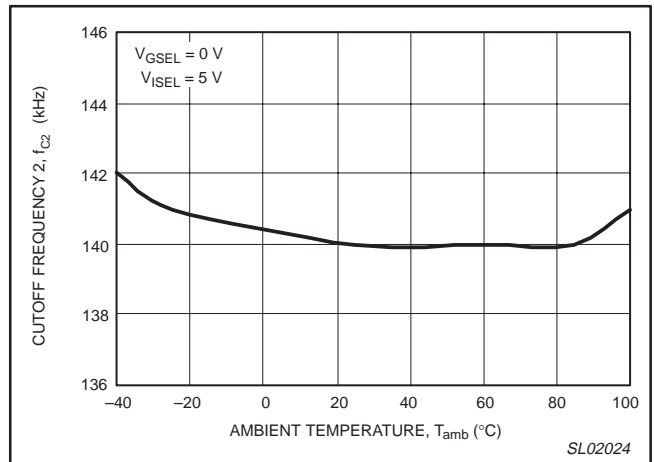

Figure 30. Cutoff frequency 2 versus ambient temperature.

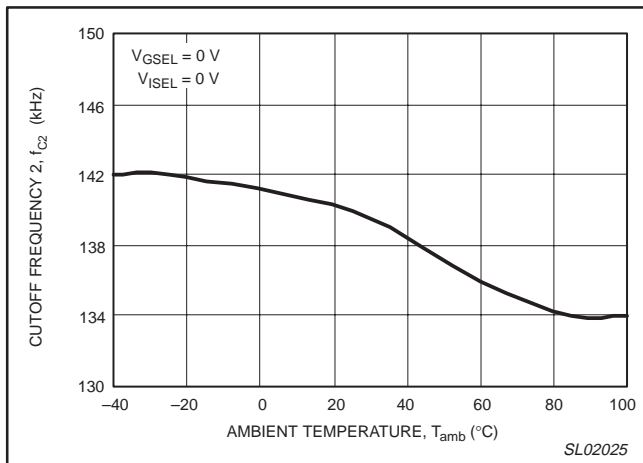

Figure 31. Cutoff frequency 2 versus ambient temperature.

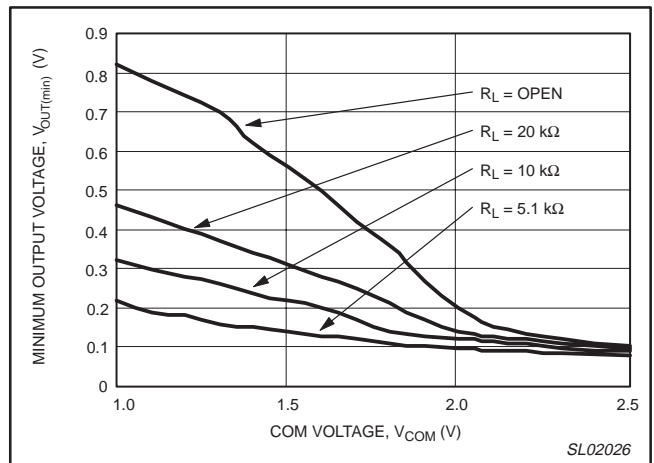

Figure 32. Minimum output voltage versus COM voltage.

Sense current amplifier with selectable gain

SA58780

TYPICAL CHARACTERIZATION CURVES (continued)

$V_{CC} = 5.0\text{ V}$; $V_{GSEL} = V_{ISEL} = 5\text{ V}$; $R_L = 10\text{ k}\Omega$; $T_{amb} = 25\text{ }^\circ\text{C}$; unless otherwise specified.

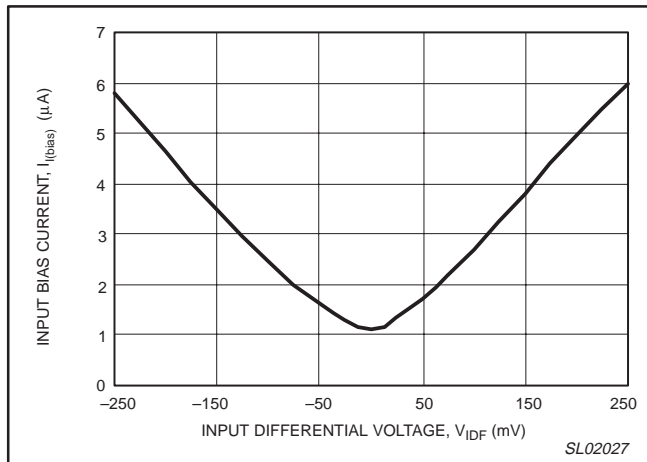

Figure 33. Input bias current versus input differential voltage.

APPLICATION INFORMATION

Battery current sensing circuit

The circuit shown in Figure 34 will sense when the load is drawing current from the battery, and the output of Pin 6 to an analog-to-digital converter can be used to provide a digital readout.

Pin 8, the Gain Select, is tied to ground. This gives a fixed G_V of 50 V/V. For a fixed G_V of 100 V/V, tie Pin 8 to V_{CC} . For selectable gain, Pin 8 may be connected to a user-controlled selector switch or the output of another device that will change state as the current rises and falls.

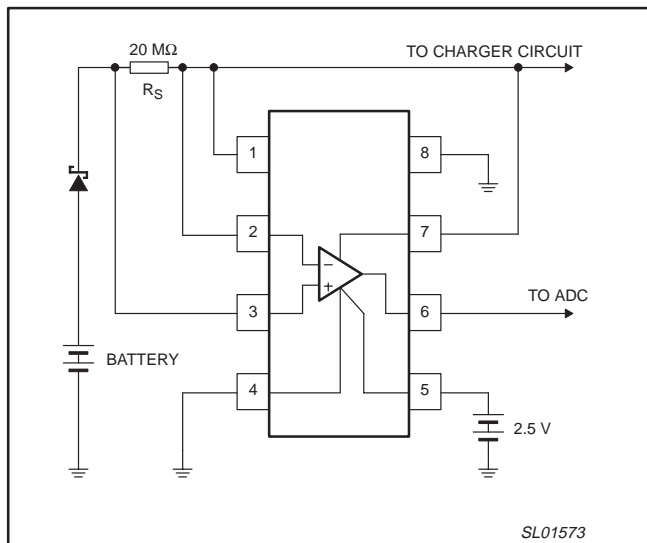

Figure 34. Battery current sensing circuit.

Charger current sensing

The only difference between the battery and charge current sense circuits is the diode position.

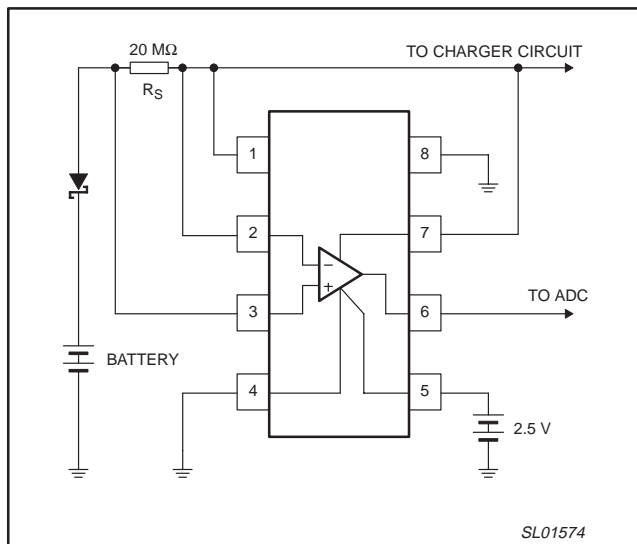

Figure 35. Charger current sensing circuit.

Sense current amplifier with selectable gain

SA58780

PACKING METHOD

The SA58780 is packed in reels, as shown in Figure 36.

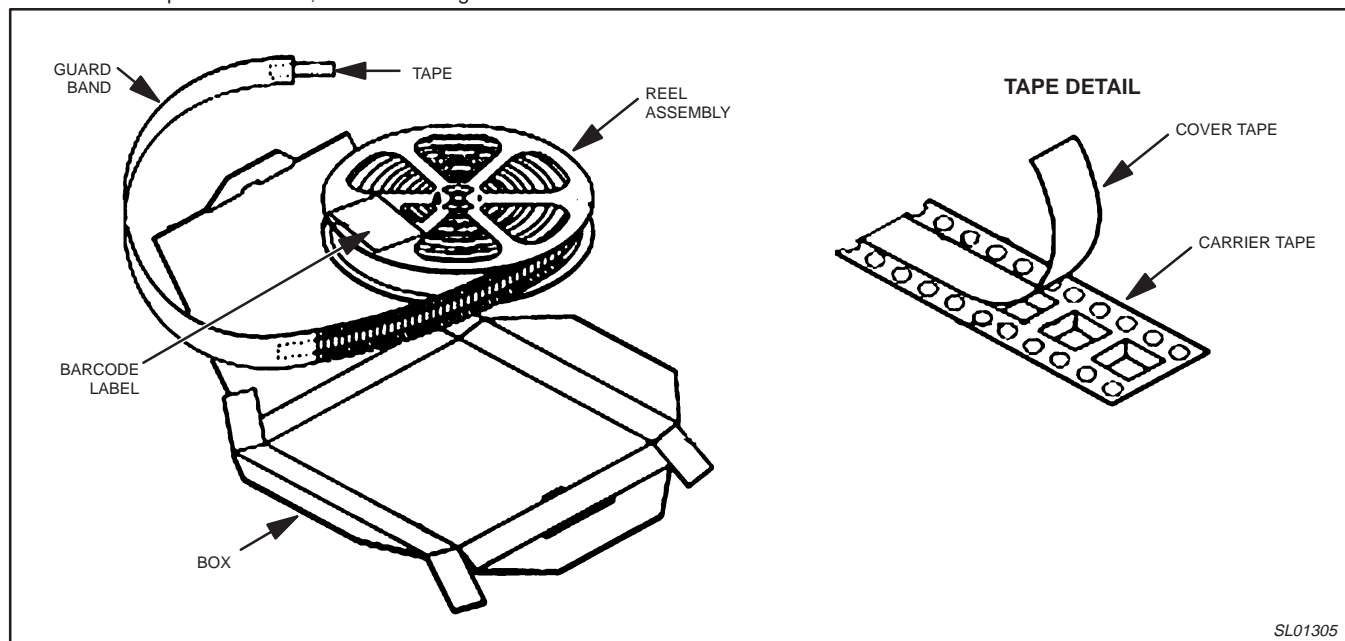

Figure 36. Tape and reel packing method

SL01305

Sense current amplifier with selectable gain

SA58780

S08: plastic small outline package; 8 leads; body width 3.9 mm

SOP005

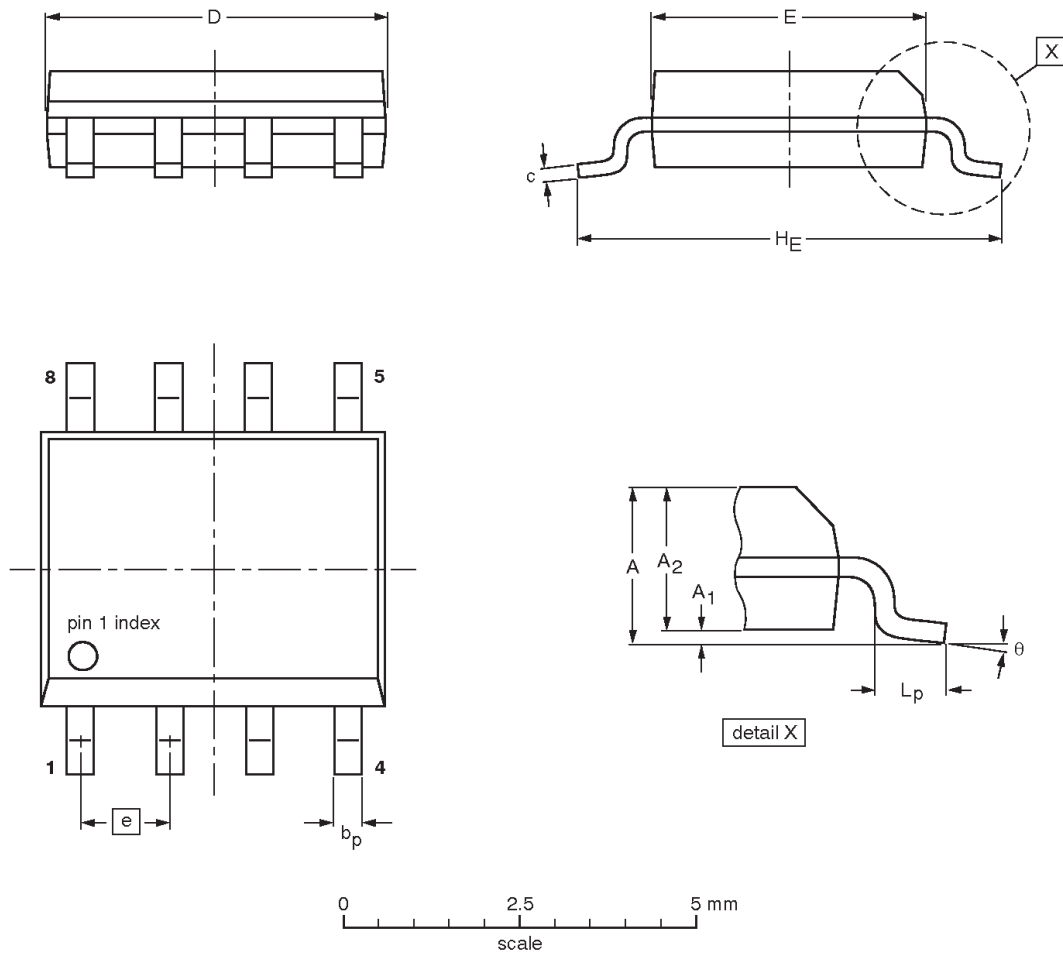

DIMENSIONS (inch dimensions are derived from the original mm dimensions)

UNIT	A max.	A ₁	A ₂	b _p	c	D ⁽¹⁾	E ⁽²⁾	e	H _E	L _p	θ
mm	1.73	0.25 0.10	1.45 1.25	0.51 0.33	0.25 0.19	4.95 4.80	4.0 3.8	1.27	6.2 5.8	1.27 0.38	8° 0°
inches	0.068	0.010 0.004	0.057 0.049	0.013 0.020	0.0100 0.0075	0.20 0.19	0.16 0.15	0.050	0.244 0.228	0.050 0.015	

Notes

1. Plastic or metal protrusions of 0.15 mm maximum per side are not included.
2. Plastic or metal protrusions of 0.25 mm maximum per side are not included.

OUTLINE VERSION	REFERENCES				EUROPEAN PROJECTION	ISSUE DATE
	IEC	JEDEC	JEITA			
SOP005	076E03	MS-012				03-10-07

Sense current amplifier with selectable gain

SA58780

REVISION HISTORY

Rev	Date	Description
_3	20031110	Product data (9397 750 12303); ECN 853–2290 30333 of 09 September 2003. Supersedes data of 2002 Dec 10 (9397 750 10746). Modifications: <ul style="list-style-type: none">• Change package outline version to SOP005 in Ordering information table and Package outline sections.
_2	20021210	Product data (9397 750 10746); ECN 853–2290 29179 of 11 November 2002. Supersedes data of 2001 Oct 03 (9397 750 08982).
_1	20011003	Product data; initial version (9397 750 08982). ECN 853–2290 27197 of 03 October 2001.

Sense current amplifier with selectable gain

SA58780

Data sheet status

Level	Data sheet status ^[1]	Product status ^{[2] [3]}	Definitions
I	Objective data	Development	This data sheet contains data from the objective specification for product development. Philips Semiconductors reserves the right to change the specification in any manner without notice.
II	Preliminary data	Qualification	This data sheet contains data from the preliminary specification. Supplementary data will be published at a later date. Philips Semiconductors reserves the right to change the specification without notice, in order to improve the design and supply the best possible product.
III	Product data	Production	This data sheet contains data from the product specification. Philips Semiconductors reserves the right to make changes at any time in order to improve the design, manufacturing and supply. Relevant changes will be communicated via a Customer Product/Process Change Notification (CPCN).

[1] Please consult the most recently issued data sheet before initiating or completing a design.

[2] The product status of the device(s) described in this data sheet may have changed since this data sheet was published. The latest information is available on the Internet at URL <http://www.semiconductors.philips.com>.

[3] For data sheets describing multiple type numbers, the highest-level product status determines the data sheet status.

Definitions

Short-form specification — The data in a short-form specification is extracted from a full data sheet with the same type number and title. For detailed information see the relevant data sheet or data handbook.

Limiting values definition — Limiting values given are in accordance with the Absolute Maximum Rating System (IEC 60134). Stress above one or more of the limiting values may cause permanent damage to the device. These are stress ratings only and operation of the device at these or at any other conditions above those given in the Characteristics sections of the specification is not implied. Exposure to limiting values for extended periods may affect device reliability.

Application information — Applications that are described herein for any of these products are for illustrative purposes only. Philips Semiconductors make no representation or warranty that such applications will be suitable for the specified use without further testing or modification.

Disclaimers

Life support — These products are not designed for use in life support appliances, devices, or systems where malfunction of these products can reasonably be expected to result in personal injury. Philips Semiconductors customers using or selling these products for use in such applications do so at their own risk and agree to fully indemnify Philips Semiconductors for any damages resulting from such application.

Right to make changes — Philips Semiconductors reserves the right to make changes in the products—including circuits, standard cells, and/or software—described or contained herein in order to improve design and/or performance. When the product is in full production (status 'Production'), relevant changes will be communicated via a Customer Product/Process Change Notification (CPCN). Philips Semiconductors assumes no responsibility or liability for the use of any of these products, conveys no license or title under any patent, copyright, or mask work right to these products, and makes no representations or warranties that these products are free from patent, copyright, or mask work right infringement, unless otherwise specified.

Contact information

For additional information please visit
<http://www.semiconductors.philips.com>. Fax: +31 40 27 24825

© Koninklijke Philips Electronics N.V. 2003
 All rights reserved. Printed in U.S.A.

Date of release: 11-03

For sales offices addresses send e-mail to:
sales.addresses@www.semiconductors.philips.com

Document order number:

9397 750 12303

Let's make things better.